



**HLM
PNEUMÁTICA**

HLM

CATÁLOGO ELÉTRICA



HLM PNEUMÁTICA
www.molasflexyon.com.br
HLM

AGRALE	
Elétrica.....	2
CASE	
Elétrica.....	2
FIAT	
Elétrica.....	2
FIAT-ALLIS	
Elétrica.....	3
FORD	
Elétrica.....	3
IVECO	
Elétrica.....	3
KOMATSU	
Elétrica.....	5
MAN	
Elétrica.....	5
MERCEDES-BENZ	
Elétrica.....	6
ÔNIBUS	
Elétrica.....	11
SCANIA	
Elétrica.....	11
VOLARE	
Elétrica.....	19
VOLKSWAGEN	
Elétrica.....	19
VOLVO	
Elétrica.....	21



Referência
9390453023 BOSCH

Referência
6011011047884 AGRALE
F006B20021 BOSCH

Aplicação
MOTOR DO LIMPADOR DE
PÁRABRISA 12V

Aplicação
MOTOR DO LIMPADOR DE
PÁRABRISA 24V

CASE - Elétrica



Referência
82017881 CASE
0281002209 BOSCH
BG5X10884AA FORD
12628120 GMC

Aplicação
SENSOR DE TEMPERATURA

FIAT - Elétrica



Referência
9390453024 BOSCH
F006WM0308 BOSCH

Aplicação
MOTOR DO LIMPADOR DE
PÁRABRISA 24V



00544672

Referência

9390453024 BOSCH
F006WM0308 BOSCH

Aplicação

MOTOR DO LIMPADOR DE
PÁRABRISA 24V

FORD - Elétrica



imagem indisponível

09107

Referência

Aplicação

CHAVE DO LIMPADOR
PÁRABRISAS
CARGO 814 / 815 / 815E / 915 /
1215 / 1217 / 1317 / 1317E / 1415 /
1417 / 1421 / 1517E / 1521 / 1617 /



00563499

Referência

Aplicação

8300025 DELCO
8200072 DELCO
8200000 DELCO
19026030 DELCO
MOTOR DE PARTIDA 7.5KW
CARGO - 2632 / 2932 / 4532 / 5032
com motores Cummins ISC 320



07634

Referência

Aplicação

9390453021 BOSCH
MOTOR DO LIMPADOR DE
PÁRABRISA 12V
CARGO 814 / 815 / 1317 / 1517 /
1717 com motores 4BTAA



00564557

Referência

Aplicação

BG5X6C315AA FORD
0281002411 BOSCH
4890190 CUMMINS
6013101090006 MARCOPOLO
SENSOR DE ROTAÇÃO
CARGO 1317 / 1517 / 1717 - 3.9L ;
1722 / 2422 / 2428 / 2622 / 2628 - 5.
9L ; 815E Electronic 3.9L ; F250 -
3.9L

IVECO - Elétrica



00563444

Referência

Aplicação

4892320 IVECO
4892318 IVECO
0986045430 BOSCH
0120655005 BOSCH
ALTERNADOR 100A
EUROCARGO 170E22 / 170E24



00563482

Referência

Aplicação

504028095 IVECO
500315943 IVECO
0123525502 BOSCH
ALTERNADOR 90A
720T42T STRALIS - 200S38 /
200S42 / 450S38HR / 450S38T /
450S38TP / 450S42HR / 450S42T /
450S42TP / 570S38T / 570S42T /



00562003

Referência

Aplicação

4837683 IVECO
COMUTADOR DE IGNIÇÃO



00551298

Referência

Aplicação

42531807 IVECO
6ZF 182 914-001 HELLA
D35083 VDO
0501210058 ZF
INTERRUPTOR LUZ / RÉ
Eurotech 450E37 / Power Star
450E37T com transmissões 16S
1650 Stralis com transmissões
16S 221 / 16S 2280 TO e 16S 2320

IVECO - Elétrica

HLM PNEUMÁTICA

			
00533003	00532938	00532990	00532945
Referência 42531176 IVECO 1197311212 BOSCH	Referência 931550069 IVECO 1197311029 BOSCH	Referência 93155548 IVECO 1197311004 BOSCH	Referência 8198422 IVECO 1197311300 BOSCH
Aplicação REGULADOR VOLTAGEM 12V	Aplicação REGULADOR VOLTAGEM 12V	Aplicação REGULADOR VOLTAGEM 12V	Aplicação REGULADOR VOLTAGEM 24V

IVECO - Elétrica

			
00532969	00532976	00533010	00549417
Referência 9988935 IVECO 1197311317 BOSCH	Referência 1162829 IVECO 2404417 IVECO 0192033003 BOSCH 300586 CUMMINS	Referência 93158421 IVECO 1197311304 BOSCH	Referência 504073323 IVECO 501073323 IVECO 6112001370003 AGRALE 0261230099 BOSCH
Aplicação REGULADOR VOLTAGEM 24V	Aplicação REGULADOR VOLTAGEM 24V	Aplicação REGULADOR VOLTAGEM 24V	Aplicação SENSOR DE PRESSAO TURBO EuroStar / Trakker / Stralis / Eurocargo

IVECO - Elétrica

			
00564564	00564557	00564540	00564526
Referência 4861291 IVECO 0192115012 BOSCH	Referência 4890190 IVECO 0281002411 BOSCH 4890190 CUMMINS 6013101090006 MARCOPOLO	Referência 99450797 IVECO 0281002165 BOSCH	Referência 0281002209 BOSCH BG5X10884AA FORD 12628120 GMC 4005 MTE THOMSON
Aplicação SENSOR DE ROTAÇÃO Eurocargo - 65 E 14; 65 E 14K; 80 E 18; 80 E18K; 130 E 23; 150 E 27; 150 E 27R Eurostar - LD 190 E 52; LD 240 E 47 P Eurotech	Aplicação SENSOR DE ROTAÇÃO Eurocargo	Aplicação SENSOR DE ROTAÇÃO Eurocargo / Eurostar / Eurotech MP / Eurotrakker / Stralis / Trakker	Aplicação SENSOR DE TEMPERATURA

IVECO - Elétrica

HLM PNEUMÁTICA



00564533



00561044



00535007

Referência

500382599 IVECO
0281002744 BOSCH
97227219 GMC
90541520 GMC

Referência

5010412449 IVECO
0281002742 BOSCH
0261210151 BOSCH

Referência

93191481 IVECO
0501208795 ZF

Aplicação

SENSOR DE TEMPERATURA
Daily II - Box Body / Flatbed
Daily III - Box Body / Dumptruck
/ Flatbed Eurostar LD Stralis AD /
AT Stralis AS Trakker AD / AT

Aplicação

SENSOR DO TACÔMETRO
STRALIS AD / AT / AS TRAKKER
AD / AT

Aplicação

SENSOR INDUTIVO 89mm
EUROTECH 450E37 POWERSTAR
450E37T com caixas 16S1650

KOMATSU - Elétrica



00544658



00544672



00532976

Referência

9390453023 BOSCH

Referência

9390453024 BOSCH
F006WM0308 BOSCH

Referência

6102617 KOMATSU
0192033003 BOSCH
300586 CUMMINS

Aplicação

MOTOR DO LIMPADOR DE
PÁBRISA 12V

Aplicação

MOTOR DO LIMPADOR DE
PÁBRISA 24V

Aplicação

REGULADOR TENSÃO 24V

MAN - Elétrica



09022



00564588



00564595



00561044

Referência

81.25509.0144 MAN
81.25509.0085 MAN
81.25509.0118 MAN
81.25509.0123 MAN

Referência

51.27421.0216 MAN
51.27421.0198 MAN
0281002655 BOSCH
62.27421-0216

Referência

51.27120.7038 MAN
0281002662 BOSCH
62.27120-7038
INTERNATIONAL

Aplicação

CHAVE DE SETA E LIMPADOR
TG-L ; TG-M TG-A ; TG-S ; TG-X
SL ; SU NL ; NG ; ND ; NM Lion's
/ Neoplan

Aplicação

SENSOR DE PRESSÃO DO AR
TGX ; TGA ; TGL ; TGM ; TGS

Aplicação

SENSOR DE ROTAÇÃO
TGX ; TGA ; TGL ; TGM ; TGS

Referência

0281002742 BOSCH
0261210151 BOSCH

Aplicação

SENSOR DO TACÔMETRO
TGX 26.440 TGX 28.440 TGX 33.
440

MERCEDES-BENZ - Elétrica

HLM PNEUMÁTICA



00563406



00563468



00494922



00559904

Referência
0091549802 MERCEDES-BENZ
6033GB3054 BOSCH
6033GB3027 BOSCH
6033GB3022 BOSCH

Aplicação
ALTERNADOR 80A
1215C / 1218 / 1318 / 1418 / 712C
Atego 1315 / 1418 / 1518 / 1718 /
1725 LO 914C / LO 915 / OH 1418
com motores OM904LA e

Referência
0131544002 MERCEDES-BENZ
0121541002 MERCEDES-BENZ
0986042370 BOSCH
0124555002 BOSCH

Aplicação
ALTERNADOR 80A
1215C / 1315 / 1418 / 1518 / 1718 /
1725 / 1728 / 2423 / 2425 / 712C /
914C LO / 915C / 915 LO L1218 /
L1418 / L1622 O500 M / O500 R /

Referência
0085450124 MERCEDES-BENZ

Aplicação
CHAVE DE SETA COM COMANDO
DO COMPUTADOR DE BORDO
O500 / 1938S / 1944S / AXOR

Referência
0085450124 MERCEDES-BENZ
0085451524 MERCEDES-BENZ

Aplicação
CHAVE DE SETA COM COMANDO
DO COMPUTADOR DE BORDO

MERCEDES-BENZ - Elétrica



00564502



00567978



00566469



00551298

Referência
0035455113 MERCEDES-BENZ
0025455113 MERCEDES-BENZ

Aplicação
COMANDO ELÉTRICO
COMPLETO
Axor / Actros / Atego

Referência
0025452013 MERCEDES-BENZ

Aplicação
COMANDO ELÉTRICO passageiro
Axor / Actros / Atego

Referência
0045455414 MERCEDES-BENZ

Aplicação
INTERRUPTOR BALAO
ATEGO/AXOR

Referência
0055454514 MERCEDES-BENZ
6ZF 182 914-001 HELLA
D35083 VDO
0501210058 ZF

Aplicação
INTERRUPTOR LUZ / RÉ
O500R / L1728 / OF1732 / OF1730
/ IBC1833/30 / O400 RSE / O400
RSD com transmissões S6-1550
2423K com transmissões 9S-75

MERCEDES-BENZ - Elétrica



00502283



00502252



07984



00502269

Referência
0005454909 MERCEDES-BENZ

Aplicação
INTERRUPTOR LUZ FREIO
LS1924 / 1929 / 1932

Referência
0005456009 MERCEDES-BENZ

Aplicação
INTERRUPTOR LUZ FREIO
O370 / R / RS / RSD

Referência
0015457409 MERCEDES-BENZ
0015451709 MERCEDES-BENZ

Aplicação
INTERRUPTOR MARCHA À RÉ
1620 ; 1621 ; 1720 ; 1938 ; Todos
1725 ATEGO

Referência
000.545.87.14 MERCEDES-
BENZ

Aplicação
INTERRUPTOR MARCHA À RÉ
O 371

MERCEDES-BENZ - Elétrica

HLM PNEUMÁTICA



09064

Referência
0015422317 MERCEDES-BENZ
3455427417 MERCEDES-BENZ
3022-C MTE THOMSON

Aplicação
INTERRUPTOR TÉRMICO



09066

Referência
0025427317 MERCEDES-BENZ
3845427117 MERCEDES-BENZ
3030 MTE THOMSON

Aplicação
INTERRUPTOR TÉRMICO 100°C



imagem indisponível

09068

Referência
0045455524 MERCEDES-BENZ
3049-L MTE THOMSON

Aplicação
INTERRUPTOR TÉRMICO 97°C



00563529

Referência
0061517601 MERCEDES-BENZ
10479626 DELCO
10461470 DELCO

Aplicação
MOTOR DE PARTIDA 4.5KW
1215 / 1418EL / 1718 / 1725 / 2423
/ 2428 / 712C / 715 / 915C EL 1218
/ L1218 / L1418 / LO914C O500M /
O500U / OF1417 com motores

MERCEDES-BENZ - Elétrica



imagem indisponível

08060

Referência
0048206742 MERCEDES-BENZ
0038205042 MERCEDES-BENZ
0038202742 MERCEDES-BENZ

Aplicação
MOTOR DO LIMPADOR DE
PÁRABRISA



00544658

Referência
3458247201 MERCEDES-BENZ
9390453023 BOSCH

Aplicação
MOTOR DO LIMPADOR DE
PÁRABRISA 12V
1316 / 1317 1414 / 1418 1513 /
1517 / 1519 / 1520 1630 2013 /
2020 2213 / 2214 / 2216 / 2217 /



00544641

Referência
6948247001 MERCEDES-BENZ
9390453086 BOSCH

Aplicação
MOTOR DO LIMPADOR DE
PÁRABRISA 12V
1720 e 1723 com motor OM 366



00544597

Referência
6888247301 MERCEDES-BENZ
9390453032 BOSCH

Aplicação
MOTOR DO LIMPADOR DE
PÁRABRISA 12V
709 / 912 / 1614 / 1618 / 1621 /
1630 / 1721 / 1825 / 1941 / 2314 /
2325 / 2318 ; O710 / LO812

MERCEDES-BENZ - Elétrica



00544603

Referência
3848247101 MERCEDES-BENZ
9390453033 BOSCH

Aplicação
MOTOR DO LIMPADOR DE
PÁRABRISA 24V
1214 / 1217 / 1218 / 1414 / 1418 /
1614 / 1618 / 1621 / 1630 / 1717 /
1935 / 1938 / 1941 / 2324 / 2318



00544580

Referência
3258247001 MERCEDES-BENZ
9390453022 BOSCH

Aplicação
MOTOR DO LIMPADOR DE
PÁRABRISA 24V
O 370 R ; O 370 RS ; O 370 RSD ;
O 371 R ; O400R ; O 400 UP



00544672

Referência
3508247201 MERCEDES-BENZ
9390453024 BOSCH
F006WM0308 BOSCH

Aplicação
MOTOR DO LIMPADOR DE
PÁRABRISA 24V
O355 / 364 / 365 ; O371R / RS /
RSD / UP PLATAFORMA O371R /
RWS / RSD / UPA / UP 2423



00544757

Referência
6968247001 MERCEDES-BENZ
9390453084 BOSCH

Aplicação
MOTOR DO LIMPADOR DE
PÁRABRISA 24V
1618M ; 2428 ; LS1938 ; LS2638 ;
914 LO ; 712 C ; 912 ; 915 com
motor OM 904 LA

MERCEDES-BENZ - Elétrica

HLM PNEUMÁTICA



00532938



00533003



00533010



00532945

Referência

0021546506 MERCEDES-BENZ
1197311029 BOSCH

Referência

0021548502 MERCEDES-BENZ
1197311212 BOSCH

Referência

0021548406 MERCEDES-BENZ
1197311304 BOSCH

Referência

0001541705 MERCEDES-BENZ
1197311300 BOSCH

Aplicação

REGULADOR VOLTAGEM 12V

Aplicação

REGULADOR VOLTAGEM 12V

Aplicação

REGULADOR VOLTAGEM 24V

Aplicação

REGULADOR VOLTAGEM 24V

MERCEDES-BENZ - Elétrica



00532952



00532976



00557000



00511483

Referência

0021543806 MERCEDES-BENZ
0192053005 BOSCH

Referência

0021540206 MERCEDES-BENZ
0011548806 MERCEDES-BENZ
0192033003 BOSCH
300586 CUMMINS

Referência

0335215146 BOSCH
4DM003944091 HELLA
5010168944 IVECO
2937735M91 KOMATSU

Referência

10201670 MERCEDES-BENZ
3645457724 MERCEDES-BENZ

Aplicação

REGULADOR VOLTAGEM 24V

Aplicação

REGULADOR VOLTAGEM 24V

Aplicação

RELÉ DO PISCA
O302 / O305

Aplicação

RELE LIMPADOR PARA-BRISAS

MERCEDES-BENZ - Elétrica



00511476



07941



07938



00550529

Referência

3865457124 MERCEDES-BENZ
6205400624 MERCEDES-BENZ

Referência

0005429618 MERCEDES-BENZ
4410327280 WABCO

Referência

0015423118 MERCEDES-BENZ
4410324880 WABCO

Referência

0105427817 MERCEDES-BENZ
0105427818 MERCEDES-BENZ
81259370010 MAN
81259370015 MAN

Aplicação

RELE LIMPADOR PARA-BRISAS
COM SUPORTE

Aplicação

SENSOR 90° ABS - dianteiro
direito
1938S / LS1938

Aplicação

SENSOR 90° ABS - dianteiro
esquerdo
1938S / LS1938

Aplicação

SENSOR DE ALTURA ECAS 24V
OH 1621 L

MERCEDES-BENZ - Elétrica

HLM PNEUMÁTICA



00562287



09085



imagem indisponível

00566438



imagem indisponível

09081

Referência
0005424080 MERCEDES-BENZ
0005424018 MERCEDES-BENZ
98472878 IVECO
5010143095 IVECO

Aplicação
SENSOR DE ALTURA ECAS 24V
OH 1421 L

Referência
0015405317 MERCEDES-BENZ
6345400017 MERCEDES-BENZ

Aplicação
SENSOR DE NÍVEL DA ÁGUA DO
TANQUE DE EXPANSÃO
O500

Referência
9795420318 MERCEDES-BENZ

Aplicação
SENSOR DE PRESSÃO DO AR
O500

Referência
0125420517 MERCEDES-BENZ

Aplicação
SENSOR DE PRESSÃO DO ÓLEO
1938

MERCEDES-BENZ - Elétrica



00560948



00557344



00513562



00513784

Referência
0041532028 MERCEDES-BENZ
0281002246 BOSCH
4893926 CUMMINS

Aplicação
SENSOR DE PRESSÃO DO ÓLEO
ATEGO 1315 / 1318 / 1418 / 1518 /
1718 / 1944 / 2423 / 2428 / 2628
OM904 / OM906

Referência
0071530828 MERCEDES-BENZ

Aplicação
SENSOR DE PRESSÃO DO ÓLEO
Atego 1718

Referência
0045424317 MERCEDES-BENZ

Aplicação
SENSOR DE PRESSÃO DO ÓLEO
CAMINHOS E ONIBUS L1521

Referência
3825427417 MERCEDES-BENZ
00555 SIMILAR

Aplicação
SENSOR DE QUEBRA DA
CORREIA
O400

MERCEDES-BENZ - Elétrica



00565851



00562775



00566292



imagem indisponível

09069

Referência
0011531520 MERCEDES-BENZ
0011531920 MERCEDES-BENZ
0011531620 MERCEDES-BENZ
0011532020 MERCEDES-BENZ

Aplicação
SENSOR DE ROTAÇÃO
1938S / LS1938 / 2638

Referência
0041534228 MERCEDES-BENZ

Aplicação
SENSOR DE TEMPERATURA
Motores eletrônicos 904 / 926 /
924

Referência
0055450324 MERCEDES-BENZ
3136 MTE THOMSON

Aplicação
SENSOR DE TEMPERATURA

Referência
3761537228 MERCEDES-BENZ
3080 MTE THOMSON

Aplicação
SENSOR DE TEMPERATURA
103°C
447 HG

MERCEDES-BENZ - Elétrica

HLM PNEUMÁTICA



imagem indisponível

09070



00561051



00562270



00555326

Referência
0045425617 MERCEDES-BENZ
3091 MTE THOMSON

Aplicação
SENSOR DE TEMPERATURA
105°C

Referência
0025403517 MERCEDES-BENZ
3344636 EATON
215920102501F VDO

Aplicação
SENSOR DE VELOCIDADE

Referência
0125425317 MERCEDES-BENZ
0135426717 MERCEDES-BENZ

Aplicação
SENSOR DE VELOCIDADE

Referência
0135426217 MERCEDES-BENZ
0155422417 MERCEDES-BENZ

Aplicação
SENSOR DE VELOCIDADE DO
CÂMBIO
L1620 / L1622 / L1725 / 1938LS /
1938S / O500 / 1720 / OF1417 /
OF1421

MERCEDES-BENZ - Elétrica



00560955



00533898



00560962



00513616

Referência
0041537028 MERCEDES-BENZ
0281002468 BOSCH

Aplicação
SENSOR DO TUBO DE
ADMISSÃO
Actros ; Atego ; Axor O 403 ; O
407 ; O 530 ; O 345 ; O 550 ; O 510
; O 350 ; O 500 ; O 580 OM904 /

Referência
0011533120 MERCEDES-BENZ
0011532120 MERCEDES-BENZ

Aplicação
SENSOR EIXO DE COMANDO
ATEGO 715 / 715L / 716 / 716L /
815 / 815L / 815K / 816 / 816L /
816K / 915 / 915L / 916 / 916L /
916K / 1015K / 1016K / 1016 /

Referência
0041531828 MERCEDES-BENZ
0281002244 BOSCH

Aplicação
SENSOR PRESSÃO /
TEMPERATURA
Actros ; Atego ; Axor O 530 ; O
520 ; O 345 ; O 403 ; O 510 ; O 350
; O 500 ; O 580

Referência
6845427217 MERCEDES-BENZ
0015425617 MERCEDES-BENZ

Aplicação
SENSOR PRESSAO OLEO
OM366

MERCEDES-BENZ - Elétrica



00513579



imagem indisponível

07939



00562232

Referência
0045428917 MERCEDES-BENZ
3455427317 MERCEDES-BENZ

Aplicação
SENSOR PRESSAO OLEO 12V /
24V
CAMINHOS E ONIBUS

Referência
0005429718 MERCEDES-BENZ
4410327270 WABCO

Aplicação
SENSOR RETO ABS - traseiro
direito
1938S / LS1938

Referência
0015423318 MERCEDES-BENZ
4410324870 WABCO

Aplicação
SENSOR RETO ABS - traseiro
esquerdo
1938S / LS1938



00544832



00544849

Referência

11.907.233.C00 ORIGINAL
31.907.243.000 ORIGINAL

Aplicação

MOTOR DO LIMPADOR DE PÁRABRISA 24V com carrocerias Marcopolo, Caio, Comil (eixo curto)

Referência

11.907.333.C00 ORIGINAL
31.907.343.000 ORIGINAL

Aplicação

MOTOR DO LIMPADOR DE PÁRABRISA 24V com carrocerias Marcopolo, Caio, Comil (eixo longo)

SCANIA - Elétrica



00563451



00563413



00557001



imagem indisponível

00547833

Referência

1442788 SCANIA
1475569 SCANIA
571614 SCANIA
571439 SCANIA

Aplicação

ALTERNADOR 100A P94 ; R124 com motores Euro III / Euro IV / Euro V 94L UB com motores Euro III

Referência

571498 SCANIA
1409380 SCANIA
1409378 SCANIA
1394969 SCANIA

Aplicação

ALTERNADOR 65A 114 / 144 / T124 P94 - 220 / 260 / 310 R94 - 310 F94 - 220 / 310 K94 - 310 K94IB / K114IB / K124IB L94 - 220 / 260 / 310 L94IB com

Referência

1425019 SCANIA

Aplicação

BLOQUEIO DO ARRANQUE SERIE 4

Referência

1520737 SCANIA
1305527 SCANIA
R032DHB508 DANFOSS
042N080300 DANFOSS

Aplicação

BOBINA PARA CAMBIO SV- S-4 - 24 V

SCANIA - Elétrica



00478878



00492713



00543958



00492676

Referência

224051 SCANIA
234387 SCANIA

Aplicação

BOTAO DA MANOPLA DE 10 MARCHAS K113 ; P93 ; R113 / R143 ; T113

Referência

290951 SCANIA

Aplicação

BOTAO DO FAROL F113 / K113 / L113 / R113 / T113

Referência

1421856 SCANIA

Aplicação

BOTÃO DO VIDRO Caminhões P / G / R / T Ônibus F / K / N

Referência

1368831 SCANIA
1413146 SCANIA

Aplicação

BOTÃO DO VIDRO P94 / P114 / P124 ; R114 / R124 ; T114 / T124

SCANIA - Elétrica

HLM PNEUMÁTICA

			 <i>imagem indisponível</i>
00492737	00502078	00502054	07972
Referência 1317885 SCANIA 1377386 SCANIA	Referência 1373189 SCANIA 1402448 SCANIA 202647 SWF	Referência 1373190 SCANIA 1402449 SCANIA	Referência 1422111 SCANIA 1542529 SCANIA
Aplicação BOTAÓ MANOPLA CAMBIO R143	Aplicação CHAVE DE SETA S-4	Aplicação CHAVE DE SETA COM COMANDO COMPUTADOR DE BORDO S-4	Aplicação CHAVE DE SETA E LIMPADOR Caminhões P ; G ; R ; T Ônibus F ; K ; N

SCANIA - Elétrica

 <i>imagem indisponível</i>			
07971	00555395	00495004	00495011
Referência 330892 SCANIA	Referência 1402450 SCANIA 1424970 SCANIA 202648 SWF	Referência 252491 SCANIA	Referência 360247 SCANIA 201726 SWF
Aplicação CHAVE DO LIMPADOR 112	Aplicação CHAVE DO LIMPADOR PÁRABRISAS S-4	Aplicação CHAVE DO LIMPADOR PÁRABRISAS 111	Aplicação CHAVE DO LIMPADOR PÁRABRISAS 113

SCANIA - Elétrica

			
00494953	00494854	00494885	00532921
Referência 347893 SCANIA 367326 SCANIA 201816 SWF	Referência 252490 SCANIA	Referência 1358175 SCANIA 360248 SCANIA 201725 SWF	Referência 371910 SCANIA
Aplicação CHAVE SETA 112	Aplicação CHAVE SETA 111	Aplicação CHAVE SETA 113	Aplicação COMUTADOR ELETRICO IGNICAO E PARTIDA S-4

SCANIA - Elétrica





HLM PNEUMÁTICA

	 <i>imagem indisponível</i>		
00502108	08066	00543415	00562546
Referência 353626 SCANIA 1488067 SCANIA	Referência 290955 SCANIA	Referência 371146 SCANIA 1434808 SCANIA	Referência 353627 SCANIA
Aplicação INTERRUPTOR S4	Aplicação INTERRUPTOR	Aplicação INTERRUPTOR S4	Aplicação INTERRUPTOR 3 estágios - levantamento eixo 113

SCANIA - Elétrica





			
00562539	00562522	00549486	00533225
Referência 353623 SCANIA	Referência 353625 SCANIA	Referência 375734 SCANIA 1303472 SCANIA	Referência 367327 SCANIA 1450115 SCANIA 1371213 SCANIA
Aplicação INTERRUPTOR 3 estágios - levantamento eixo traseiro 113 - 114	Aplicação INTERRUPTOR 3 estágios - luz da cabine 113 - 114	Aplicação INTERRUPTOR bloqueio do diferencial R770 / R780 / RP831	Aplicação INTERRUPTOR bloqueio do diferencial R113 / 143 ; T113 ; R124

SCANIA - Elétrica

		 <i>imagem indisponível</i>	
00549479	00502498	08065	00502382
Referência 343795 SCANIA 1303471 SCANIA 370710 SCANIA 81.25520.0050 MAN	Referência 314572 SCANIA	Referência 290947 SCANIA	Referência 1423965 SCANIA 1472738 SCANIA
Aplicação INTERRUPTOR DA CAIXA GR871 / PONTO MORTO / LUZ DE RE 112HW / 113 P 230 / 270 / 310 / 420 / 470 R 230 / 310 / 340 / 380 / 420 / 470 / 500 / 580 G 420	Aplicação INTERRUPTOR DA RE / PONTO NEUTRO F112 / T112 / R112 / S112 / K112 T142 / R142 (G770)	Aplicação INTERRUPTOR DESEMBAÇADOR DO VIDRO 112 / 142 / 113	Aplicação INTERRUPTOR DO EIXO COROA E PINHAO R780

SCANIA - Elétrica

HLM PNEUMÁTICA

			
00502399	00502238	00557771	00533157
Referência 353621 SCANIA 1488066 SCANIA	Referência 288649 SCANIA	Referência 1360842 SCANIA	Referência 1327015 SCANIA
Aplicação INTERRUPTOR DO FAROL AUXILIAR E ESPELHO S4	Aplicação INTERRUPTOR DO FREIO 112 ; P93 ; F113 ; K113 ; R113 / 143 ; T113	Aplicação INTERRUPTOR DO PEDAL DE EMBREAGEM 94 / 114 / 124 / 164	Aplicação INTERRUPTOR DO PISCA ALERTA S-4

SCANIA - Elétrica

			
00502191	00502375	00502092	00533218
Referência 1328177 SCANIA 290950 SCANIA 1363131 SCANIA	Referência 1350317 SCANIA	Referência 353628 SCANIA	Referência 1420005 SCANIA 1472739 SCANIA
Aplicação INTERRUPTOR DO PISCA ALERTA P93 ; F113 ; K113 ; R113 / 143 ; T113 ; L113	Aplicação INTERRUPTOR DO RETARDER S4	Aplicação INTERRUPTOR ELETRICO T113 ; R113 / 143 ; S-4	Aplicação INTERRUPTOR eng. planetaria / trava difere. / tomada força S-4 ; P / G / R / T ; F / K / N

SCANIA - Elétrica

			
00551298	09086	00563512	00563505
Referência 6ZF 182 914-001 HELLA D35083 VDO 0501210058 ZF	Referência 1361131 SCANIA	Referência 1796026 SCANIA 1447911 SCANIA 0986021480 BOSCH 0001241001 BOSCH	Referência 1358639 SCANIA 1357709 SCANIA 0986017760 BOSCH 0001371007 BOSCH
Aplicação INTERRUPTOR LUZ / RÉ F95 com transmissões S6-1550	Aplicação INTERRUPTOR PRESSÃO DO AR S4	Aplicação MOTOR DE PARTIDA 5.5KW G230 / G270 / G310 / G320 / G340 / G360 / G380 / G400 / G420 / G440 / G470 / G480 / P230 / P270 / P280 com motores 8.9L / 9.3L / 10.6L /	Aplicação MOTOR DE PARTIDA 6.7KW K124 P114 / P124 / R114 / R124 / T124 com motores DSC12 / DC11

SCANIA - Elétrica

HLM PNEUMÁTICA

			 <i>imagem indisponível</i>
00544610	00544634	00544665	08062
Referência 1958048 SCANIA 537152 SCANIA 9390453030 BOSCH XC4517504BA FORD	Referência 1677081 SCANIA 9390453071 BOSCH	Referência 1858661 SCANIA 1360371 SCANIA 1318506 SCANIA 1392755 SCANIA	Referência 1765185 SCANIA 1922234 SCANIA
Aplicação MOTOR DO LIMPADOR DE PÁRABRISA 24V R112 / R112-310 / R112-360 T112 ; T112-310 ; T112-360 R113-320 ; R142 ; R142-410 ; R143-450	Aplicação MOTOR DO LIMPADOR DE PÁRABRISA 24V R112 / R113 / R142 / R143 T112 / T113 / T142 / T143 F112HL ; K113TL eixo longo	Aplicação MOTOR DO LIMPADOR DE PÁRABRISA 24V P94 / P114 / P124 / P230 / P270 / P310 / P340 / P380 / P420 R114 / 124	Aplicação MOTOR DO LIMPADOR DE PÁRABRISA 24V P / G / R / T

SCANIA - Elétrica

 <i>imagem indisponível</i>			
07700	00556972	00538107	00538091
Referência 9130081060 BOSCH	Referência 1357713 SCANIA 1401436 SCANIA 1495692 SCANIA 0130111184 BOSCH	Referência 396828 SCANIA 1406616 SCANIA	Referência 396827 SCANIA 1406615 SCANIA
Aplicação MOTOR DO VENTILADOR Caminhões R e T 112-310 / 112- 360 / 113-320 / 143-450 Ônibus F113HL ; K113CL ; K113CL ; K113TL ; L113CL ; S113AL ;	Aplicação MOTOR DO VENTILADOR SERIE 4	Aplicação MOTOR DO VIDRO DIREITO 113	Aplicação MOTOR DO VIDRO ESQUERDO 113

SCANIA - Elétrica

			
00556965	00553148	00533010	00556998
Referência 1366762 SCANIA 560098 SCANIA 1442293 SCANIA	Referência 1366761 SCANIA 560097 SCANIA 1442292 SCANIA	Referência 1118188 SCANIA 1117253 SCANIA 1197311304 BOSCH	Referência 303535 SCANIA 1407909 SCANIA 1543731 SCANIA 1439172 SCANIA
Aplicação MOTOR LEVANTAMENTO VIDRO L.D. S4	Aplicação MOTOR LEVANTAMENTO VIDRO L.E. S4	Aplicação REGULADOR VOLTAGEM 24V 113 e Serie 4	Aplicação RELÉ Ônibus série 3 Ônibus F / K / N - série 4 Caminhões P / G / R / T - série 4

SCANIA - Elétrica

HLM PNEUMÁTICA



00511438



00511407



00556996



00556927

Referência

1431781 SCANIA
1391322 SCANIA
243460 SCANIA

Aplicação

RELE AUXILIAR 5 VIAS
P93 ; F113 ; K113 ; L113 ; R113 /
143 ; T113 ; serie 4

Referência

243460 SCANIA
235940 SCANIA
228600 SCANIA

Aplicação

RELE AUXILIAR DE 4 SAIDAS
P93 ; F113 ; K113 ; L113 ; R113 /
143 ; T113 ; serie 4

Referência

1902698 SCANIA
1504270 SCANIA
1401788 SCANIA
RL9921 SIMILAR

Aplicação

RELE COMUTADOR DO FAROL
S-4

Referência

1386988 SCANIA
1388858 SCANIA

Aplicação

RELÉ DE PARTIDA
SÉRIE 4

SCANIA - Elétrica



00557009



00557023



00529914



00511490

Referência

1328548 SCANIA
1401789 SCANIA
4DN007431021 HELLA
RL9912 SIMILAR

Aplicação

RELÉ DO PISCA
S-4

Referência

1334196 SCANIA
365559 SCANIA
289929 SCANIA
334470 SCANIA

Aplicação

RELÉ DO PISCA
T 93 H - 250 / 280 T 113 E - 320 /
360 T 113 H - 320 / 360 T 143 E -
420 / 450 / 500 T 143 H - 420 / 450 /
500

Referência

334470 SCANIA

Aplicação

RELE INDICADOR DIRECAO
(SETA)
FTRSK112/TR142/K113/

Referência

331881 SCANIA
363712 SCANIA
301490 SCANIA
42069398 FIAT

Aplicação

RELE LIMPADOR PARA-BRISAS
P93 ; F113 ; K113 ; L113 ; R113 /
143 ; T113

SCANIA - Elétrica



00482677



00511537



00511384



07944

Referência

1543806 SCANIA
1475750 SCANIA
1387022 SCANIA
5DA 006 779-041 HELLA

Aplicação

RELE MONITOR DE ROTACAO
TROCA DE CAIXA
S-4

Referência

1741091 SCANIA
1902328 SCANIA
1523612 SCANIA
1335482 SCANIA

Aplicação

RELE TEMPORIZ.LIMPADOR
PARA-BRISA

Referência

383740 SCANIA

Aplicação

RELE TRANSFERENCIA
113

Referência

1892053 SCANIA
1530699 SCANIA
1428443 SCANIA
4410328650 WABCO

Aplicação





SENSOR 90° ABS - traseiro
direito
R124 (6x2) / R124 (6x4) T124 (6x4)

SCANIA - Elétrica

HLM PNEUMÁTICA

			
00533140	00562287	00564861	09148
Referência 1316331 SCANIA	Referência 1379941 SCANIA 1398840 SCANIA 98472878 IVECO 5010143095 IVECO	Referência 1495828 SCANIA 4410501010 WABCO	Referência 478495 SCANIA 1496308 SCANIA
Aplicação SENSOR DA PRESSAO DO OLEO porcelana 113	Aplicação SENSOR DE ALTURA ECAS 24V P124 R124 T124	Aplicação SENSOR DE ALTURA ECAS 24V Caminhões P / G / R / T Ônibus F / K / N	Aplicação SENSOR DE COMANDO DO ACELERADOR (potenciometro) K94 / K114 / K124 / L94 / N94

SCANIA - Elétrica

			
02358	00556033	09149	00533201
Referência 1364185 SCANIA	Referência 1731309 SCANIA 1794440 SCANIA	Referência 481829 SCANIA 5010207803 IVECO 0504002113 KNORR 1.25591 SIMILAR	Referência 1757083 SCANIA 1454477 SCANIA 1731130 SCANIA
Aplicação SENSOR DE COMANDO DO ACELERADOR (potenciometro) Serie 4 com motores D9A / D9M / D12M / D12A / D14A / D14M / D16A e D16M	Aplicação SENSOR DE DESGASTE S-4 F / K / N	Aplicação SENSOR de nível ÔNIBUS Série 4	Aplicação SENSOR DE PRESSAO Onibus S-4

SCANIA - Elétrica

			
00566445	00566834	00565516	00564885
Referência 368851 SCANIA 397946 SCANIA	Referência 1448083 SCANIA 1541703 SCANIA 1781199 SCANIA 4410441050 WABCO	Referência 1881260 SCANIA 1393113 SCANIA 1488340 SCANIA 1452862 SCANIA	Referência 1535521 SCANIA 1862892 SCANIA
Aplicação SENSOR DE PRESSAO DO AR N113 ; K93 / K113 ; L113	Aplicação SENSOR DE PRESSÃO DO AR P / G / R / TF / K / N	Aplicação SENSOR DE PRESSÃO DO ÓLEO S-4	Aplicação SENSOR DE PRESSÃO DO ÓLEO P114 ; R114 / R124 ; T114 / T124 com motores DC11 / D12 PDE e DT12 / DC12 HPI Caminhões: P / G / R / T Ônibus: F / K / N

SCANIA - Elétrica

HLM PNEUMÁTICA



00551281



00566452



09065



00564878

Referência
1881260 SCANIA
1393113 SCANIA
1488340 SCANIA
1452862 SCANIA

Aplicação
SENSOR DE PRESSÃO DO ÓLEO
S-4

Referência
373811 SCANIA
374338 SCANIA

Aplicação
SENSOR DE PRESSÃO DO ÓLEO
10 BAR
P93 ; K113 ; R143

Referência
309065 SCANIA
3455427717 MERCEDES-BENZ
3022-L MTE THOMSON
323801001046N VDO

Aplicação
SENSOR DE TEMPERATURA
T112 / T142 / T113 / T143 R112 /
R142 / R113 / R143

Referência
1445040 SCANIA
1526158 SCANIA

Aplicação
SENSOR DE TEMPERATURA
K94 / K114 / K124 / K432 F114 /
F124 com caixas GR801R

SCANIA - Elétrica



07985



00483056



00548991



00482981

Referência
1742947 SCANIA
1852113 SCANIA
1516563 SCANIA
217120002501 VDO

Aplicação
SENSOR DE VELOCIDADE
ônibus 113 e S-4 caminhões P / G
/ R / T ; ônibus F / K / N com
caixas GR875 / GR875R / GRO905
/ GRO905R / GRS895 / GRS895R /

Referência
1111459 SCANIA

Aplicação
SENSOR DE VELOCIDADE DO
CAMBIO
K113 S-4 com caixas GT811 /
GR801 / GR801R / GR871 / GR880
/ GR900 / GRS900 / GRH900

Referência
1111459 SCANIA
215950004501F VDO

Aplicação
SENSOR DE VELOCIDADE DO
CAMBIO
K113 S-4 com caixas GT811 /
GR801 / GR801R / GR871 / GR880
/ GR900 / GRS900 / GRH900

Referência
264816 SCANIA
395641 SCANIA

Aplicação
SENSOR DE VELOCIDADE DO
CÂMBIO
Séries 3 e 4

SCANIA - Elétrica



00549462



00564892



07940



07945

Referência
264816 SCANIA
395641 SCANIA

Aplicação
SENSOR DE VELOCIDADE DO
CÂMBIO
Séries 3 e 4

Referência
1862798 SCANIA
1784636 SCANIA
1545634 SCANIA
1402943 SCANIA

Aplicação
SENSOR DO TUBO DE
ADMISSÃO
Série 4 com motores DCS12 - 01,
03, 05 / DC12 e DT12

Referência
1892054 SCANIA
1530700 SCANIA
1534519 SCANIA
1431120 SCANIA

Aplicação
SENSOR RETO ABS - dianteiro
esquerdo
R124 (6x2) / R124 (6x4) T124 (6x4)

Referência
1892061 SCANIA
1530710 SCANIA
1441278 SCANIA
4410329140 WABCO

Aplicação
SENSOR RETO ABS - traseiro
direito
K124

SCANIA - Elétrica

HLM PNEUMÁTICA



00564854



00516495

Referência

1397851 SCANIA
1491408 SCANIA

Aplicação

SENSOR TEMPERATURA DO
RETARDER
113 ; 114

Referência

1678102 SCANIA
389500 SCANIA

Aplicação

TRAVA DE DIRECAO COM
CILINDRO E COMUTADOR
T 112 / 113

VOLARE - Elétrica



00564557

Referência

0281002411 BOSCH
4890190 CUMMINS
6013101090006 MARCOPOLO
961200670024 MWM

Aplicação

SENSOR DE ROTAÇÃO
W8o 01/05 W9 01/06 ACTEON - 4.
12 TCE

VOLKSWAGEN - Elétrica



imagem indisponível

09105



09106



imagem indisponível

09107



00551298

Referência

2TJ953513 VOLKSWAGEN
TJG953513 VOLKSWAGEN

Aplicação

CHAVE DE SETA

Referência

2R0953513 VOLKSWAGEN

Aplicação

CHAVE DE SETA
Ônibus 5.140E OD / 8.120 OD / 8.
150 OD / 8.150E OD / 9.150 OD / 9.
150E OD / 15.480E OD / 17.210 OD
/ 17.210E OD / 17.240 OT / 18.310

Referência

TJG953519A VOLKSWAGEN

Aplicação

CHAVE DO LIMPADOR
PÁRABRISAS
Ônibus 16.180 CO / 16.210 CO

Referência

2T0919823 VOLKSWAGEN
6ZF 182 914-001 HELLA
D35083 VDO
0501210058 ZF

Aplicação

INTERRUPTOR LUZ / RÉ
18.310 / 19.320 / 31.320 com
transmissões 16S 1650 8.160E
com transmissões S5-420 19.370 /
25.370 / 31.370 com transmissões

VOLKSWAGEN - Elétrica

HLM PNEUMÁTICA



imagem indisponível

09063



00544719



00544702



07854

Referência
2TJ919501 VOLKSWAGEN
745 MTE THOMSON

Aplicação
INTERRUPTOR TÉRMICO

Referência
TAC955113 VOLKSWAGEN
9390453050 BOSCH

Aplicação
MOTOR DO LIMPADOR DE
PÁRABRISA 12V
7.100 8.100 / 8.140 12.140H / 12.
170 / 12.180 13.150 / 13.180 / 13.
170 14.150 / 14.170 / 14.180 / 14.

Referência
2T0955113 VOLKSWAGEN
F006B20021 BOSCH

Aplicação
MOTOR DO LIMPADOR DE
PÁRABRISA 24V
13.170 / 15.170 / 17.250 / 18.310 /
23.250 / 8.150 todos Electronic

Referência
2R2955113A VOLKSWAGEN

Aplicação
MOTOR DO LIMPADOR DE
PÁRABRISA 24V
CONSTELLATION 13.180 / 15.180 /
17.250 / 19.379 / 24.250 / 25.320 /
25.370 / 26.260 / 31.260 / 31.320 /

VOLKSWAGEN - Elétrica



00532938



00532952



00562267



00564557

Referência
TRA903803 VOLKSWAGEN
1197311029 BOSCH

Aplicação
REGULADOR VOLTAGEM 12V

Referência
2RP903803A VOLKSWAGEN
0192053005 BOSCH

Aplicação
REGULADOR VOLTAGEM 24V

Referência
2Z0409270 VOLKSWAGEN
98472878 IVECO
5010143095 IVECO
81259370016 MAN

Aplicação
SENSOR DE ALTURA ECAS 24V
17.240 OT

Referência
2R0906433C VOLKSWAGEN
0281002411 BOSCH
4890190 CUMMINS
6013101090006 MARCOPOLO

Aplicação
SENSOR DE ROTAÇÃO
13.170 - 3.9L ; 13.180 - 4.7L ; 15.
170 - 3.9L ; 15.180E Electronic 4.
7L

VOLKSWAGEN - Elétrica



00564526

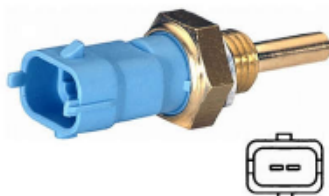

00566315



imagem indisponível

09072



00564533

Referência
2R0919501A VOLKSWAGEN
0281002209 BOSCH
BG5X10884AA FORD
12628120 GMC

Aplicação
SENSOR DE TEMPERATURA
5.140 ; 8.150 ; Microônibus 8.150E
OD ; 9.150E OD ; 13.170E ; 13.
180E ; 15.170E 15.180E ; 15.190E ;
15.190E OD ; 17.210E OD ; 17.

Referência
2TA919501 VOLKSWAGEN
3033 MTE THOMSON

Aplicação
SENSOR DE TEMPERATURA
Worker 8-140 com motor MWM 4.
10T 5.180 ; 7.100 ; 12.150 ; 13.130 ;
15.180 ; 17.300

Referência
028919501C VOLKSWAGEN
3088 MTE THOMSON

Aplicação
SENSOR DE TEMPERATURA
12.220

Referência
2R0919501B VOLKSWAGEN
0281002744 BOSCH
97227219 GMC
90541520 GMC

Aplicação
SENSOR DE TEMPERATURA



00535007

Referência

2T0927803 VOLKSWAGEN
0501208795 ZF

Aplicação

SENSOR INDUTIVO 89mm
18.310 TITAN com caixas 16S1650

VOLVO - Elétrica



00563475

Referência

85000626 VOLVO
3803639 VOLVO
20849351 VOLVO
20849349 VOLVO

Aplicação

ALTERNADOR 110A
B10M / B12B FH / FM / NH - 340 /
380 / 420 / 460 / 500 com motores
DH12 / DH12D / DH12E / D12D /
D12C



00563420

Referência

6799261 VOLVO
6779261 VOLVO
6678261 VOLVO
5003448 VOLVO

Aplicação

ALTERNADOR 55A
B12 / B12B NL10 - 320 / 340 NL12
- 360 / 410 com motores D10 /
TD102FS / TD122



00563437

Referência

8113915 VOLVO
3986429 VOLVO
8144401 VOLVO
8156817 VOLVO

Aplicação

ALTERNADOR 80A
B12 FH / FM / NH com motores
D12D - 340 / 360 / 420 / 460 / 500
NH12 com motores D12C - 380 /
420



00568371

Referência

1347063 VOLVO
3944085 VOLVO

Aplicação

BOTÃO DO VIDRO direito
NL10 BR / NL12 BR / NH12 BR /
FH12 / FH16 / FM7 / FM10 / FM12
BR

VOLVO - Elétrica



00567930

Referência

1362546 VOLVO
3944084 VOLVO

Aplicação

BOTÃO DO VIDRO esquerdo
NL10 BR / NL12 BR / NH12 BR /
FH12 / FH16 / FM7 / FM10 / FM12
BR



00494915

Referência

8155750 VOLVO
2021 SIMILAR

Aplicação

CHAVE DE SETA
N10 / NL10 / NL12 / B10M / B58E



00479066

Referência

70351705 VOLVO
8158724 VOLVO
202731 SWF

Aplicação

CHAVE DE SETA COM ALERTA
B7 / B10 / B12



00479059

Referência

1594542 VOLVO
8154792 VOLVO
201627 SWF

Aplicação





CHAVE DE SETA COM ALERTA
B10 / B12 / NL10 / NL12

VOLVO - Elétrica

HLM PNEUMÁTICA

			
00533133	00494977	00502504	00562423
Referência 20701049 VOLVO 20797840 VOLVO 20797836 VOLVO	Referência 70351704 VOLVO 8158723 VOLVO	Referência 3172170 VOLVO 202339 SWF	Referência 3944672 VOLVO 20701028 VOLVO
Aplicação CHAVE DE SETA com comando do computador de bordo FH12 / FH16 ; FM9 / FM12 ; NH12 o numero 20797838 tambem e aplicavel, porem somente para o	Aplicação CHAVE DE SETA COM COMANDO PILOTO AUTOMATICO EDC	Aplicação CHAVE DE SETA COM COMANDO PILOTO AUTOMATICO FH de 1997 a 2000	Aplicação CHAVE DO LIMPADOR B12B / B10B / B10B LE / B10L / B7L / B12 / B7R B9L / B9S / B12M / B7R / B12B / B9TL a partir de 2011 FM7 / FM10 / FM10BR / FM12

VOLVO - Elétrica

			
00562447	00562430	00479073	00565219
Referência 20700927 VOLVO 20553738 VOLVO	Referência 20424046 VOLVO 20700930 VOLVO	Referência 20704091 VOLVO 1624133 VOLVO 202341 SWF	Referência 1594959 VOLVO 2211 SCANIA 201563 SWF
Aplicação CHAVE DO LIMPADOR FM9 / FM12 / FH12 / FH16 / NH12 / B9L / B9S / B9R / B7R / B12B / B12M / B13R	Aplicação CHAVE DO LIMPADOR FM9 / FM12 / FH12 / FH16 / NH12 a partir de 2004 B9L / B9S / B7R / B12B / B12M a partir de 2011 B7L	Aplicação CHAVE DO LIMPADOR FM / NH / FH	Aplicação CHAVE DO LIMPADOR PÁRABRISAS N10 / N12 de 1980 a 1989 NL10 / NL12 de 1989 a 1995 B58 de 1979 a 1988

VOLVO - Elétrica

			
00494908	00567794	00550185	00552998
Referência 1096413 VOLVO 3172171 VOLVO 202340 SWF	Referência 20752915 VOLVO 21354597 VOLVO	Referência 20568853 VOLVO 20752914 VOLVO	Referência 20752918 VOLVO 20455314 VOLVO
Aplicação CHAVE SETA FH12 ; NH12 ; FM12 a partir de 2001 substituido por 8141578	Aplicação COMANDO ELÉTRICO FH12 / FH16 FM9 / FM12 NH12	Aplicação COMANDO ELÉTRICO FH12 / FH16 FM9 / FM12 NH12	Aplicação COMANDO ELÉTRICO COMPLETO FH12 / FH16 FM9 / FM12 NH12

VOLVO - Elétrica

HLM PNEUMÁTICA



00555401



00567923



00559911



00533232

Referência
20752919 VOLVO

Aplicação
COMANDO ELÉTRICO passageiro
FH12 / FH16 FM9 / FM12 NH12

Referência
1084000 VOLVO
8159904 VOLVO

Aplicação
COMUTADOR DE IGNIÇÃO

Referência
20953569 VOLVO
20466306 VOLVO
20466302 VOLVO
20942844 VOLVO

Aplicação
COMUTADOR DO FAROL E PISCA
ALERTA

Referência
8140797 VOLVO
1594555 VOLVO
8157751 VOLVO
20569981 VOLVO

Aplicação
INTERRUPTOR 1 estágio - farol
neblina / luz rotativa aviso
FH12 ; FM7 / FM9 / FM12 ; NH12
de 1998 em diante

VOLVO - Elétrica



00533300



00533256



00533287



00533317

Referência
3987952 VOLVO
3987951 VOLVO
1611576 VOLVO
8142986 VOLVO

Aplicação
INTERRUPTOR 1 estágio com
mola
NH12 de 1999 em diante ; FH12 /
16 ; FM7 / 9 / 10 / 12

Referência
1594566 VOLVO
1096474 VOLVO
8140807 VOLVO
8157753 VOLVO

Aplicação
INTERRUPTOR 1 estágio com
mola / trava
NH12 de 1999 em diante ; FH12 /
16 ; FM7 / 9 / 10 / 12

Referência
8157760 VOLVO

Aplicação
INTERRUPTOR 2 estágios
NH12 ; FM7 / 9 / 10 / 12 ; FH12 /
16

Referência
3197757 VOLVO
20569992 VOLVO

Aplicação
INTERRUPTOR 2 estágios do
farol de milha
NH12 de 1999 em diante ; FH12 /
16 ; FM9 / 10 / 12

VOLVO - Elétrica



00533294



00562454



09100



09098

Referência
8147040 VOLVO
1096471 VOLVO
8157761 VOLVO

Aplicação
INTERRUPTOR 3 estágios - do
freio motor
NH12 ; FM7 / 9 / 10 / 12 ; FH12 /
16

Referência
20569986 VOLVO

Aplicação
INTERRUPTOR 3 estágios -
levantamento eixo

Referência
3962939 VOLVO
1594045 VOLVO





Aplicação
INTERRUPTOR bloqueio do
diferencial
NL10 BR / NL12 BR a partir de
1992 N10 de 1980 a 1989 / N12 de
1981 a 1989 B10B / B10B LE /

Referência
3197872 VOLVO

Aplicação
INTERRUPTOR bloqueio do
diferencial
FH12 / FH16 / FM9 / FM12 / NH12 a
partir de 2004 FM7 / FM9

VOLVO - Elétrica

HLM PNEUMÁTICA

	 <i>imagem indisponível</i>	 <i>imagem indisponível</i>	
00533270	09097	09101	00549721
Referência 8157759 VOLVO	Referência 3197870 VOLVO	Referência 20367498 VOLVO	Referência 1578700 VOLVO
Aplicação INTERRUPTOR BLOQUEIO TRACAO TRUCADO 3 estagios NH12 ; FM7 / 9 / 10 / 12 ; FH12 / 16	Aplicação INTERRUPTOR caixa de mudanças / eixo FH12 com caixas VT-2014/OD ; VT-2514B e VT-2514/OD FH16 com caixas VT-2514 e VT-2514/OD	Aplicação INTERRUPTOR DA BATERIA FH12 / FH16 / FM9 / FM12 / NH12	Aplicação INTERRUPTOR DE EMERGENCIA

VOLVO - Elétrica



	 <i>imagem indisponível</i>		
00558440	09099	00502337	00533263
Referência 20560843 VOLVO	Referência 3197873 VOLVO	Referência 1594544 VOLVO	Referência 8157750 VOLVO
Aplicação INTERRUPTOR DE VACUO FM11 / FM12 / FM13 FH12 / FH13 NH12 com motores D12C / D12D	Aplicação INTERRUPTOR do eixo traseiro FH12 / FH16 / FM7 / FM9 / FM10 / FM12 / NH12 / B12B / B12M	Aplicação INTERRUPTOR DO FAROL EDC 360/410	Aplicação INTERRUPTOR DO PISCA ALERTA NH12 de 1997 em diante ; FH12 / 16 ; FM7 / 10 / 12

VOLVO - Elétrica





		 	 
00502313	00502351	00551298	00544528
Referência 1578702 VOLVO	Referência 1578704 VOLVO	Referência 20853480 VOLVO 1662939 VOLVO 6ZF 182 914-001 HELLA D35083 VDO	Referência 21318038 VOLVO 85116453 VOLVO 1662926 VOLVO 1613687 VOLVO
Aplicação INTERRUPTOR FAROL	Aplicação INTERRUPTOR LIMPADOR PARA-BRISAS N10, N12 e F10	Aplicação INTERRUPTOR LUZ / RÉ FH12 / NH12 com transmissões 16S 1650	Aplicação INTERRUPTOR LUZ / RÉ / FREIO FH12 / FH16 até 2004 NL10S / NL12S B7R / B9R / B12B / B12M a partir de 2004

VOLVO - Elétrica

HLM PNEUMÁTICA

			
00544818	00544801	00563536	00563499
Referência 1062011 VOLVO 3176550 VOLVO	Referência 1062010 VOLVO 3176549 VOLVO	Referência 85000087 VOLVO 20572417 VOLVO 20430564 VOLVO M9T62173 MITSUBISHI	Referência 20430564 VOLVO 1556968 VOLVO 11127679 VOLVO 8300025 DELCO
Aplicação MOTOR DE LEVANTAMENTO DO VIDRO DIREITO FM7 / 9 / 10 / 12 ; NH12 ; FH12 / 16	Aplicação MOTOR DE LEVANTAMENTO DO VIDRO ESQUERDO FM7 / 9 / 10 / 12 ; NH12 ; FH12 / 16	Aplicação MOTOR DE PARTIDA 5.5KW FH / FM / NH	Aplicação MOTOR DE PARTIDA 7.5KW FH / FM / NH

VOLVO - Elétrica

			
00544825	00544627	00544764	00556989
Referência 20442878 VOLVO	Referência 6888659 VOLVO 8122733 VOLVO 9390456029N BOSCH 9390453029 BOSCH	Referência 8143408 VOLVO	Referência 20936382 VOLVO 21639688 VOLVO 3090909 VOLVO
Aplicação MOTOR DO LIMPADOR DE PÁBRISA FM9 / FM12 ; FH12 / FH16 ; NH12	Aplicação MOTOR DO LIMPADOR DE PÁBRISA 24V N10 / 12 ; NL10 / 12	Aplicação MOTOR DO LIMPADOR DE PÁBRISA 24V FH12 / FH16	Aplicação MOTOR DO VENTILADOR FM7 / FM10 / FM10 BR / FM12 / FM12 BR / FH12 / FH16 / NH12

VOLVO - Elétrica

			
09102	00568005	00532969	00533010
Referência 20443824 VOLVO 20853484 VOLVO	Referência 8143940 VOLVO 8191739 VOLVO 3981596 VOLVO	Referência 1606935 VOLVO 1197311317 BOSCH	Referência 1625880 VOLVO 1197311304 BOSCH
Aplicação REGULADOR CLIMATIZADOR FM9 / FM12 / FH12	Aplicação REGULADOR DO FAROL FH16 ; FM7 / FM10 / FM12	Aplicação REGULADOR TENSÃO 24V NL10 / NL12	Aplicação REGULADOR TENSÃO 24V

VOLVO - Elétrica

HLM PNEUMÁTICA

			
00557306	00557290	00557313	00557000
Referência 1078690 VOLVO	Referência 20390648 VOLVO 21255974 VOLVO	Referência 20374662 VOLVO	Referência 1587993 VOLVO 1582410 VOLVO 1573780 VOLVO 1501686 VOLVO
Aplicação RELÉ FM7 / FM9 / FM10 / FH12 / FH16 / NH12 / B9S / B9R / B12B / B12R / B12M / B13R	Aplicação RELÉ FH12 / FH16	Aplicação RELÉ FM7 / FM9 / FM10 / FH12 / FH16 / NH12 / B9S / B9R / B12B / B12R / B12M / B13R	Aplicação RELÉ DO PISCA FH12 / FH16 FM7 / FM12 N10 NL10/12

VOLVO - Elétrica

			
00511520	00533171	00562348	00564847
Referência 8121768 VOLVO RL9905 SIMILAR	Referência 3197871 VOLVO	Referência 20562642 VOLVO	Referência 21643575 VOLVO 21253672 VOLVO 20583428 VOLVO 21585711 VOLVO
Aplicação RELE TEMPORIZADOR DO LIMPADOR PARA-BRISA N / NL	Aplicação SENSOR DA CAIXA DE CAMBIO FM9 / FM12 FH12 / FH16 NH12 VM	Aplicação SENSOR DA CAIXA DE CAMBIO FH12 B12B / B12M com caixas VT2412B	Aplicação SENSOR DE ALTURA FH12 / FH13 / FH16 FM12 / FM13 NH9 / NH12 / NH13

VOLVO - Elétrica

			
00550529	00562287	00564830	00538527
Referência 20356553 VOLVO 81259370010 MAN 81259370015 MAN 1338343 SCANIA	Referência 20356554 VOLVO 98472878 IVECO 5010143095 IVECO 81259370016 MAN	Referência 20514066 VOLVO 8144352 VOLVO 20850557 VOLVO K01374N KNORR	Referência 21399626 VOLVO 8140024 VOLVO
Aplicação SENSOR DE ALTURA ECAS 24V B7R	Aplicação SENSOR DE ALTURA ECAS 24V B7	Aplicação SENSOR de nível FH12 / FH16 / FM9 / FM12 B9R / B9L / B9S / B9TL / B7R / B12B / B12M	Aplicação SENSOR DE NÍVEL DA ÁGUA DO TANQUE DE EXPANSÃO FH12 / FH16 B7R ; B9R ; B10B / B10R ; B12M / B12B FM7 / FM10 / FM12

VOLVO - Elétrica

HLM PNEUMÁTICA



09090



00562461



00562478



00549387

Referência
21521353 VOLVO
21042477 VOLVO

Aplicação
SENSOR DE NÍVEL E
TEMPERATURA DO ÓLEO
FH12 / FM12 / NH12 a partir de
2004 B9L / B9S / B9TL / B9R /
B12R / B12B / B12M a partir de

Referência
1087961 VOLVO

Aplicação
SENSOR DE PRESSÃO
N10 / N12 / NL10 BR / NL12 BR /
FH12 / FH16

Referência
20382508 VOLVO

Aplicação
SENSOR DE PRESSÃO
NL10 / NL12 / B58E / B7R / B10B

Referência
20796744 VOLVO

Aplicação
SENSOR DE PRESSÃO CÁRTER
B9L / B9S / B9TL / B9R / B12B /
B12M FH12 / NH12 / FM12 com
motores VE12 FH16 com motores
VE16 FM com motores VE9

VOLVO - Elétrica



00561006



00562324



00564618



09077

Referência
20484678 VOLVO

Aplicação
SENSOR DE PRESSÃO
combustível
B12 / NH / FH12

Referência
20803650 VOLVO

Aplicação
SENSOR DE PRESSÃO DO AR
B12B / B12M (aplicação no
sistema de nivelamento traseiro -
vide produto similar) FM9 / FM12
; FH12 / FH16 - com motores VE9

Referência
8140526 VOLVO
3963135 VOLVO
85107132 VOLVO

Aplicação
SENSOR DE PRESSÃO DO
COLETOR
FH12 / FH16 / NH12 / B12

Referência
1606877 VOLVO
0986344074 BOSCH
0344101074 BOSCH

Aplicação
SENSOR DE PRESSÃO DO ÓLEO
N10

VOLVO - Elétrica



00549424



00548977



00562331



00549394

Referência
8143247 VOLVO
3962893 VOLVO

Aplicação
SENSOR DE PRESSÃO DO ÓLEO
FH12 / FH16 com motores D12A
até o ano de 1998

Referência
20424066 VOLVO
1077574 VOLVO

Aplicação
SENSOR DE PRESSÃO DO ÓLEO
FM7 / FM10 / FM12 B7R / B9R /
B10B / B10L / B12B / B12M FH12
/ FH16 NH12

Referência
8125160 VOLVO
360 002 018R VDO

Aplicação
SENSOR DE PRESSÃO DO ÓLEO
B10M / B12 / NL10 / NL12

Referência
20898038 VOLVO
20886108 VOLVO
21302639 VOLVO

Aplicação
SENSOR DE PRESSÃO DO ÓLEO
4 pinos
FH12 / FH16 B12B / B12M

VOLVO - Elétrica

HLM PNEUMÁTICA



00549417



00533188



00513777



00533164

Referência
20524936 VOLVO
6112001370003 AGRALE
0261230099 BOSCH
0281002576 BOSCH

Aplicação
SENSOR DE PRESSAO TURBO
B7R com motores VE7 B9L /
B9TL / B9S / B9R FH12 / FM12 /
NH12 com motores VE12 FH16
com motores VE16 FM com

Referência
20483889 VOLVO
20424051 VOLVO
20424060 VOLVO

Aplicação
SENSOR DE PRESSAO valvula de
estacionamento e ABS
FH12 / 16 ; FM9 / 12 ; B7R / B9R /
B9S / B12B / B12M / B10L / NH

Referência
20382506 VOLVO

Aplicação
SENSOR DE PRESSAO valvula
freio de mão
B7R / B9R / B12 / B10L / B10M /
B12B / B12M / B10R / B12 a partir
de 1994 FH12 / FH16 ; FL7 de

Referência
20382505 VOLVO

Aplicação
SENSOR DE PRESSAO valvula
pedal de freio
B12B / B12M / B10M / B58 F12 ;
FH12 / 16 até 1998 N10 / N12 ;
NL10 até 1992 ; NL12 até 1996 ;

VOLVO - Elétrica



00561013



00564571



09075



00562492

Referência
20796744 VOLVO
20905373 VOLVO
20499340 VOLVO

Aplicação
SENSOR DE PRESSÃO
VENTILAÇÃO DO CÂRTER
FM12 / NH / FH12 motores VE13
com EGR VE16/GEN5

Referência
3944124 VOLVO
0281002248 BOSCH

Aplicação
SENSOR DE ROTAÇÃO
B13R / B10B / B10L / B12M /
B12B / B7R / B9S / B9TL ; FH16 ;
FM10 / FM7

Referência
8141475 VOLVO
3515093 VOLVO
0265001187 BOSCH

Aplicação
SENSOR DE ROTAÇÃO
B12 com motor D12A - 420 FH12
com motores D12A / D12C e D12D
- 340 / 380 / 420 / 460

Referência
1610946 VOLVO

Aplicação
SENSOR DE TEMPERATURA
B10M / B7R / B10R / NL10

VOLVO - Elétrica



09094



00564601



00562508



00562485

Referência
1624368 VOLVO
1079338 VOLVO

Aplicação
SENSOR DE TEMPERATURA
FH12 / FH16 / NH12 a partir de
1997 / B12

Referência
1612230 VOLVO

Aplicação
SENSOR DE TEMPERATURA
B10B / B10B LE / B10M BR / B58
BR / B7R / B6R

Referência
1611153 VOLVO

Aplicação
SENSOR DE TEMPERATURA
B10R / B12 / NL12

Referência
1598855 VOLVO

Aplicação
SENSOR DE TEMPERATURA
B7R / B10M / B10R / B58 NL10

VOLVO - Elétrica

HLM PNEUMÁTICA



00560979



00564533



00551311



00560986

Referência
1578133 VOLVO

Aplicação
SENSOR DE TEMPERATURA
N10 / N12 NL10 / NL12 com
INTERCOOLER B10R / B12 / B58

Referência
20153340 VOLVO
20513340 VOLVO
0281002744 BOSCH
97227219 GMC

Aplicação
SENSOR DE TEMPERATURA
FH 400 / 420 / 440 / 460 / 480 / 500
/ 520 / 540 / 550 / 610 FH16 - 540 /
550 / 580 / 600 / 610 / 660 / 700 FM
- 330 / 360 / 370 / 380 / 390 / 400 /

Referência
1624361 VOLVO

Aplicação
SENSOR DE TEMPERATURA 4
pinos
FH12 / FH16

Referência
1594228 VOLVO

Aplicação
SENSOR DE TEMPERATURA
caixa de mudanças
VT2014 / VT2214 / VT2514

VOLVO - Elétrica



09096



00562515



00538534



00564823

Referência
20576626 VOLVO

Aplicação
SENSOR DE TEMPERATURA da
água
B7R a partir de 2012 FH12 / FH16
/ FM7 / FM12 / B7L

Referência
1080807 VOLVO

Aplicação
SENSOR DE TEMPERATURA da
água
N12

Referência
3963696 VOLVO
1079339 VOLVO
8141474 VOLVO
1619819 VOLVO

Aplicação
SENSOR DE TEMPERATURA DO
INTERCOOLER
B10M / B10R / B10B ; B12 ; NL10
/ NL10S / NL12 / VT2014 / 2214 /
254

Referência
3987882 VOLVO
20374282 VOLVO
0281002458 BOSCH

Aplicação
SENSOR DE VELOCIDADE
FH12 - 340 / 380 / 420 / 460 / 500
FH16 - 540 / 550 / 580 / 600 / 610 /
660 / 700 FM9 - 260 / 300 / 340 /
380 FM12 - 340 / 380 / 420 / 460

VOLVO - Elétrica



00549400



00561051



00549448



00561044

Referência
20508011 VOLVO

Aplicação
SENSOR DE VELOCIDADE
B9S / B9TL / B9R / B12 FH12 /
FM12 / NH12 com motores VE12
FM9 com motores VE9 FH16 com
motores VE16

Referência
20520370 VOLVO
3344636 EATON
215920102501F VDO

Aplicação
SENSOR DE VELOCIDADE
VM17 - 210 / 240 VM23 - 260

Referência
20715967 VOLVO
20893518 VOLVO

Aplicação
SENSOR DO PEDAL DO
ACELERADOR com conector 6
fios
FH12 / FH16 / FM9 / FM12 com
motores VE12, VE13 e VE16 a

Referência
20513343 VOLVO
0281002742 BOSCH
0261210151 BOSCH

Aplicação
SENSOR DO TACÔMETRO
B12 - 340 / 380 / 420 / 460 FH / FM

VOLVO - Elétrica

HLM PNEUMÁTICA



00544535



00548984



imagem indisponível

09076



00535007

Referência
70328885 VOLVO
20713344 VOLVO
20713342 VOLVO
20585479 VOLVO

Aplicação
SENSOR INDUTIVO
FH12 / FH16 NH12 FM9 / FM12
B7R / B9R / B12B / B12M
substitui 3171490

Referência
20514417 VOLVO
6781222 VOLVO
3171490 VOLVO
215920102301F VDO

Aplicação
SENSOR INDUTIVO
FH12 / FH16 FM9 / FM12 NH12
NL12S VM B6R ; B7R ; B9R ;
B10R / B10B / B10M ; B12B /
B12M

Referência
1662938 VOLVO
0501396115 ZF

Aplicação
SENSOR INDUTIVO
FH12 / NH12 com transmissões
16S1650

Referência
1662768 VOLVO
0501208795 ZF

Aplicação
SENSOR INDUTIVO 89mm
NL10 / NL12 FH12 com caixas
16S1650

VOLVO - Elétrica



00549455



00549431



00561037



00551304

Referência
3175130 VOLVO
3985226 VOLVO

Aplicação
SENSOR PEDAL ACELERADOR
conector modelo antigo
NH12 FM9 / FM10 / FM12 FH12 /
FH16 até 2005

Referência
20504685 VOLVO
3985226 VOLVO

Aplicação
SENSOR PEDAL ACELERADOR
conector modelo novo
NH12 FM9 / FM10 / FM12 FH12 /
FH16 a partir de 2005 (o código
21116880 refere-se ao conjunto)

Referência
85109590 VOLVO

Aplicação
SENSOR PEDAL DO
ACELERADOR sem fios
FM / FH com motores VE-13 e VE-
16, a partir de 2004

Referência
20478260 VOLVO
20706889 VOLVO
20374280 VOLVO

Aplicação
SENSOR PRESSÃO TURBO /
TEMPERATURA
FH12 / FM12 / NH12 - com
motores VE12 B9R / B9S / B9TL /
B12

VOLVO - Elétrica



00565691



imagem indisponível

09095

Referência
8140141 VOLVO

Aplicação
TERMINAL DO FAROL
FH12 / FH16 FM7 / FM10 / FM12
modelos até 2004

Referência
8155618 VOLVO
8154755 VOLVO

Aplicação
TERMOCONTATO
FH12 a partir de 1998 / FH16 /
NH12 a partir de 1997 / B12



**HLM
PNEUMÁTICA**

HLM

CATÁLOGO ELÉTRICA

HLM PNEUMÁTICA

TEL.: (11) 2076-8579 / 2507-1476

vendas@molasflexyon.com.br

www.molasflexyon.com.br

HLM PNEUMÁTICA

www.molasflexyon.com.br

HLM